

ACO-Gully 157 einteilig mit Geruchverschluss

Material Ablaufteile: 1.4404 (V4A) / Roste 1.4301 (V2A)

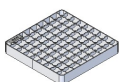

Gitterrost Klasse L15
rutschhemmend
408095
Glatt 408096

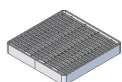

Stegrost Helsafe
Klasse L15
408031

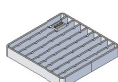

Stegrost Kl. M125
rutschhemmend
408028
Glatt 408029
Kl. C250, Glatt
408044

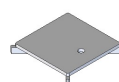

Schlitzdeckel
Klasse M125
Glatt 408030

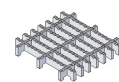

Hygieneroost
Klasse M125
rutschhemmend
446268

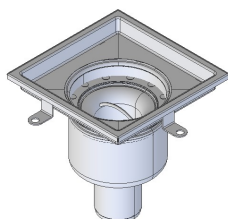
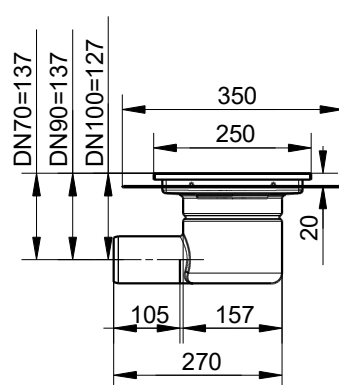
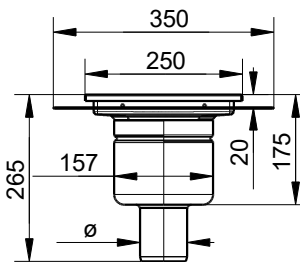
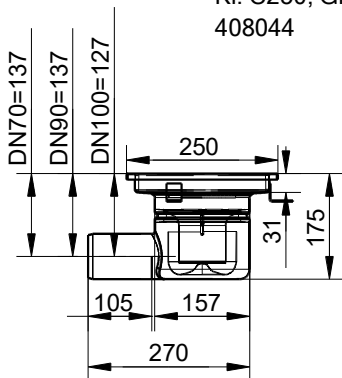
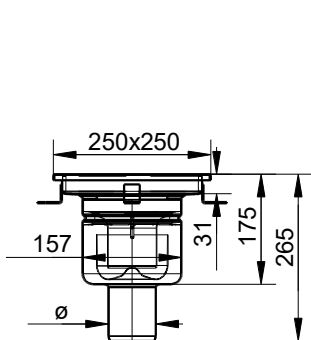

Ablaufkörper senkrecht
mit Halterand und
Geruchverschluss
ø 75 Nr. 413065
ø 90 Nr. 413066
ø 110 Nr. 413067

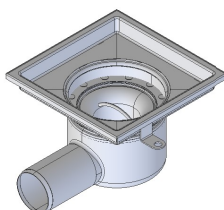

Ablaufkörper horizontal
mit Halterand und
Geruchverschluss
ø 75 Nr. 413071
ø 90 Nr. 413072
ø 110 Nr. 413073

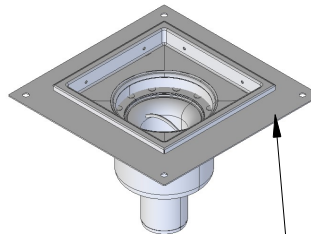

Ablaufkörper senkrecht
mit Klebeflansch und
Geruchverschluss
ø 75 Nr. 413068
ø 90 Nr. 413069
ø 110 Nr. 413070

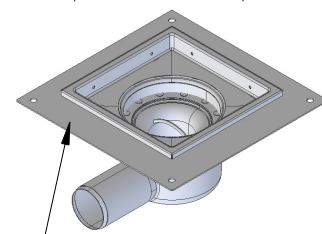

Ablaufkörper horizontal
mit Klebeflansch und
Geruchverschluss
ø 75 Nr. 413074
ø 90 Nr. 413075
ø 110 Nr. 413076

RS765
Klebeflansch mit Epoxigrund
gründiert und mit Quarzsand
abgestreut

Zubehör



3er-Set Einbaustützen
Höhe 270mm
420148



3er-Set Einbaustützen
Höhe 370mm
420149

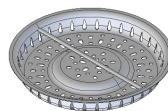

Schmutzweimer
0.3l
408203

Ersatzteile

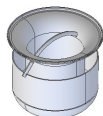

Geruchverschluss
Sperrwasserhöhe 50mm
aus 1.4404
408210

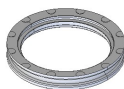

Dichtring
passend zu
Geruchverschluss
408201