

Resitec - Sifon-Unterteil ohne Klebeblech RS550.80

Massblatt / fiche technique des mesures

Material: 1.4404 (V4A)

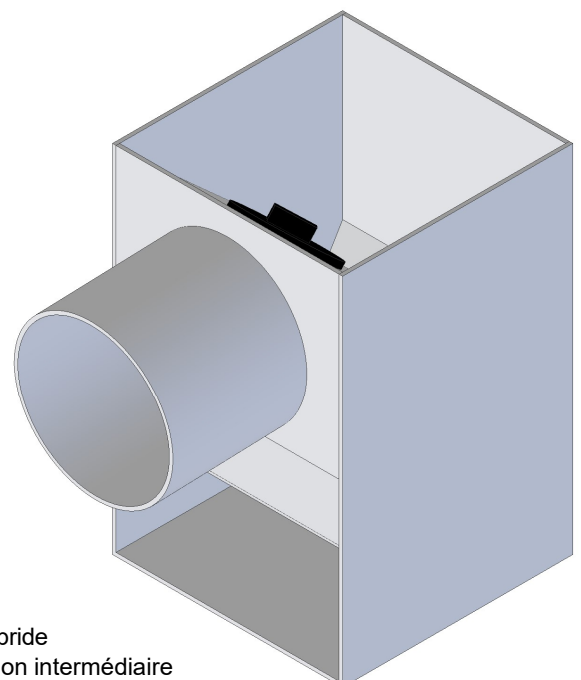
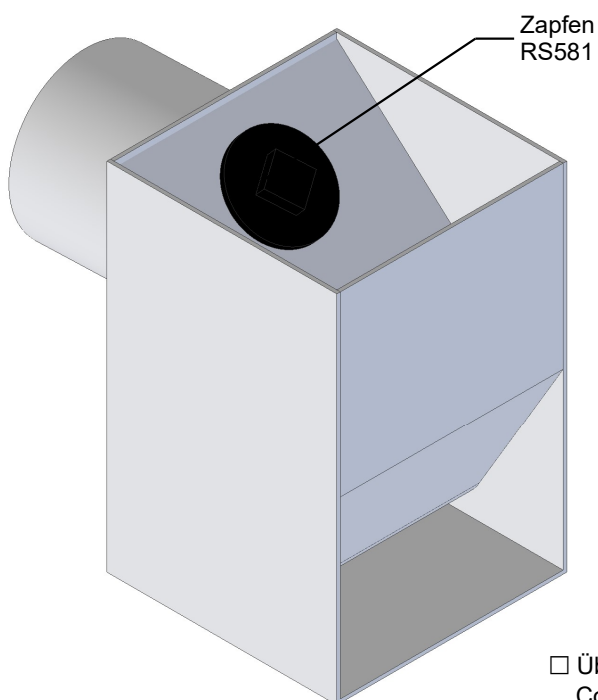
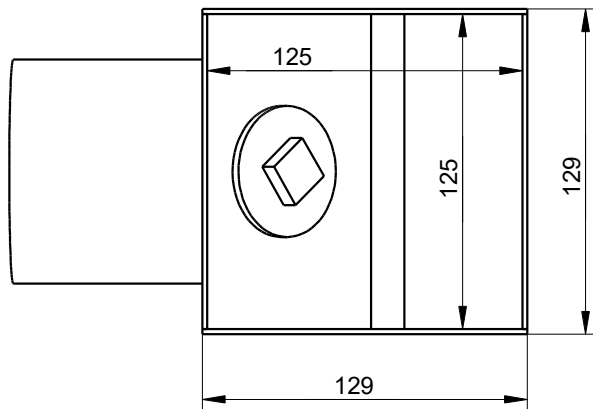
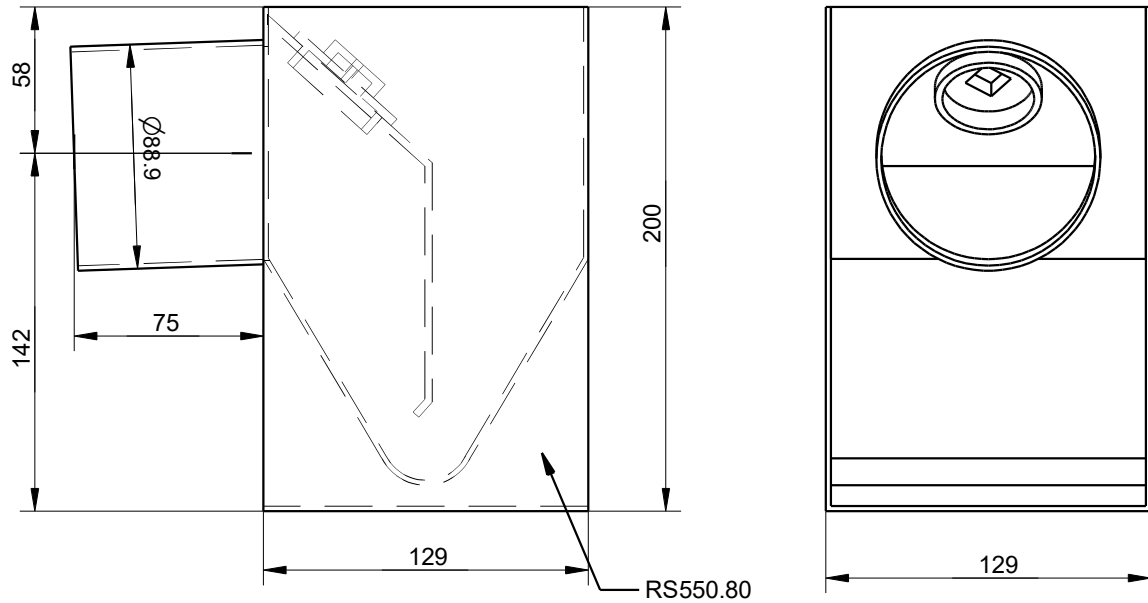

□ Übergangsbride
Collier d'union intermédiaire
Nr. 116762