

# Resitec - Sifon-Unterteil ohne Klebeblech RS560.60

## Massblatt / fiche technique des mesures

Material: 1.4404 (V4A)

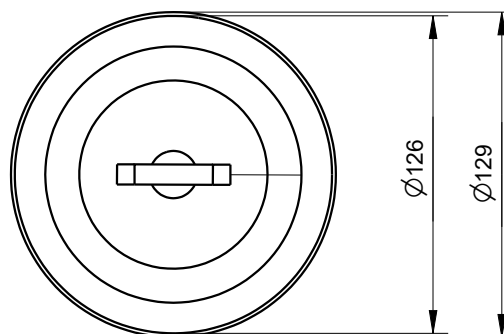
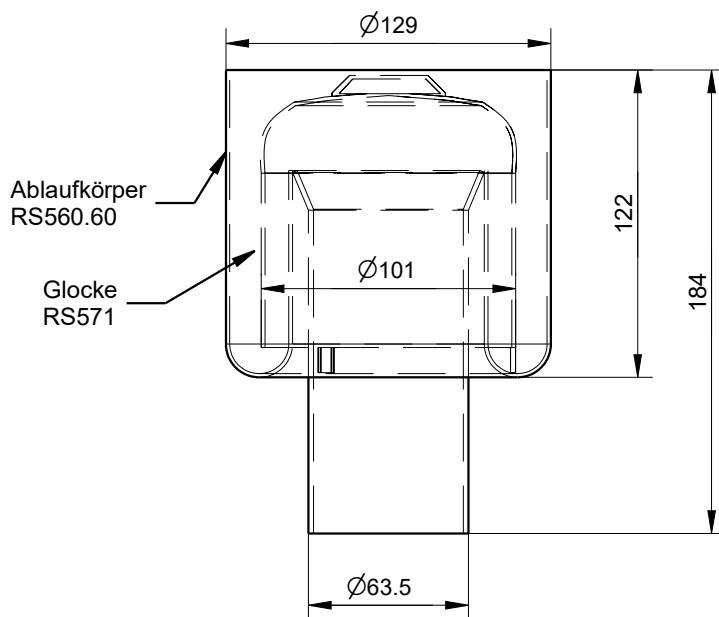

- Rückstaudichtung RS644.60  
joint de refoulement RS644.60
- Übergangsbride  
Collier d'union intermédiaire  
Nr. 116821